

Ceiling Rod Runway Kit

PRODUCT SPECIFICATION

Package includes:

- A. 5/8-11 x 6' Threaded Rod, 2 pcs
- B. Ceiling Support Bracket, 2 pcs
- C. U-Bracket, 2 pcs
- D. 5/8-11 Nut, 2 pcs

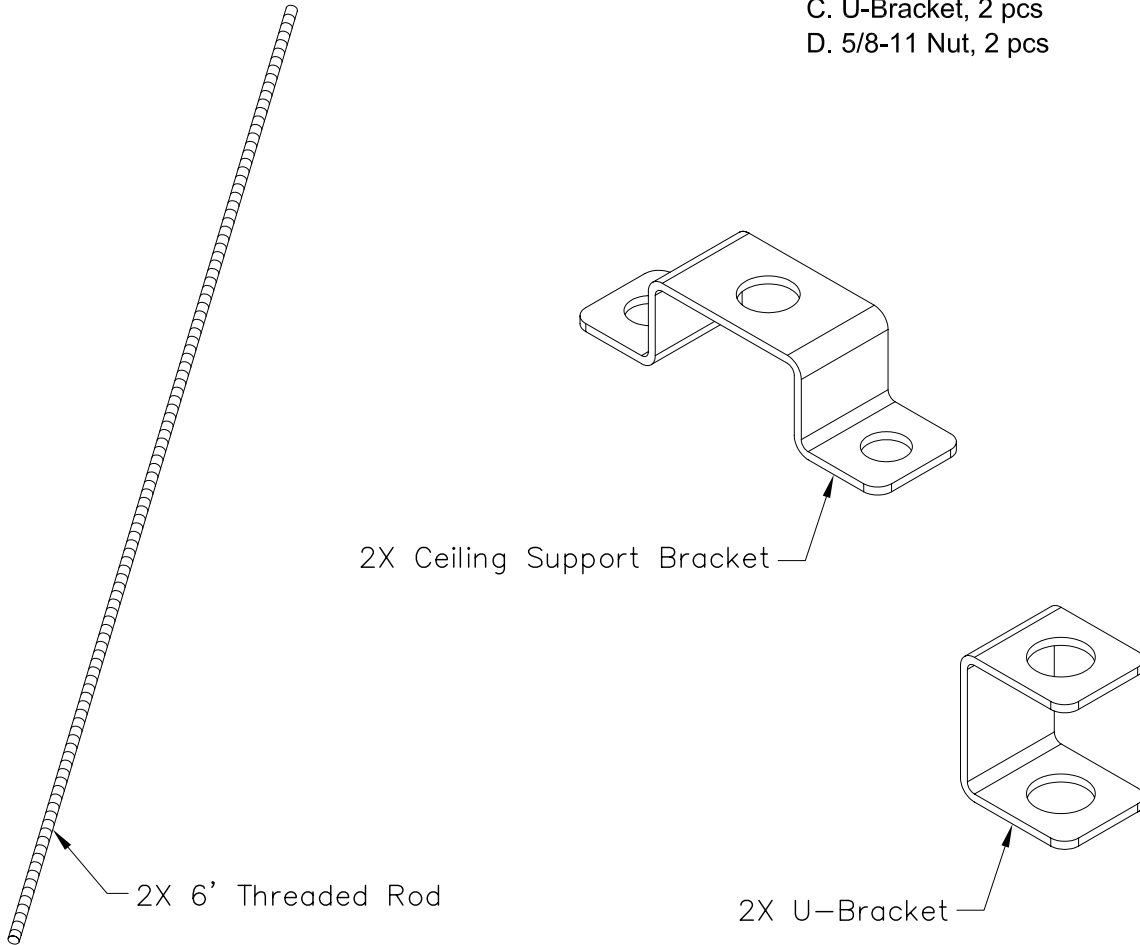

Features and Benefits:

- Designed with durable steel construction, black powder coated, providing strength and stability for long lasting use
- Designed for ceiling support and to sustain over-hanging runway sections
- Used with ICCMSLST ladder rack runways

RUNWAY KIT, CEILING ROD, 2 EA		 <i>Premium Products</i> <i>Proven Performance</i> <i>Competitive Prices</i>	
ITEM NO.	ICCMSLCMRK		REV. A
DWG NO.	PSCMSLCMRK		PAGE NO. 1

CUSTOMER CARE / TECHNICAL SUPPORT * CSR@ICC.COM / 888-ASK-4-ICC (275-4422) * 16800 Edwards Road, Cerritos, CA 90703 * Phone 562-356-3111 * Fax 562-356-3100 * www.icc.com

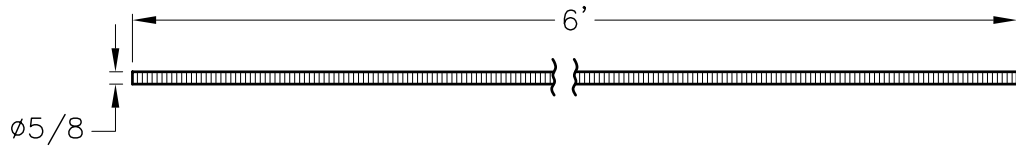

6' THREADED ROD

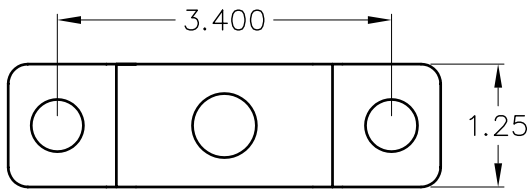

CEILING SUPPORT BRACKET

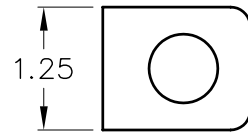

U-BRACKET

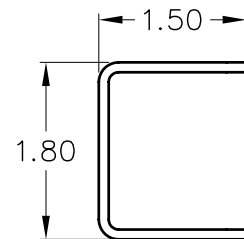
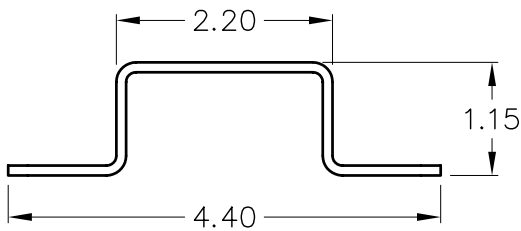

NOTE: UNLESS OTHERWISE SPECIFIED

1. 6' THREADED ROD:
 - A. MATERIAL: STEEL
2. CEILING SUPPORT BRACKET & U-BRACKET:
 - A. MATERIAL: 12 GA CRS
 - B. SURFACE FINISH: BLACK POWDER COAT

RUNWAY KIT, CEILING ROD, 2 EA		 <i>PremiumProducts</i> <i>ProvenPerformance</i> <i>CompetitivePrices</i>	
ITEM NO.	ICCMSLCMRK		REV. A
DWG NO.	PSCMSLCMRK		PAGE NO. 2

CUSTOMER CARE / TECHNICAL SUPPORT * CSR@ICC.COM / 888-ASK-4-ICC (275-4422) * 16800 Edwards Road, Cerritos, CA 90703 * Phone 562-356-3111 * Fax 562-356-3100 * www.icc.com